

QL-Series Miniature Circuit Breakers

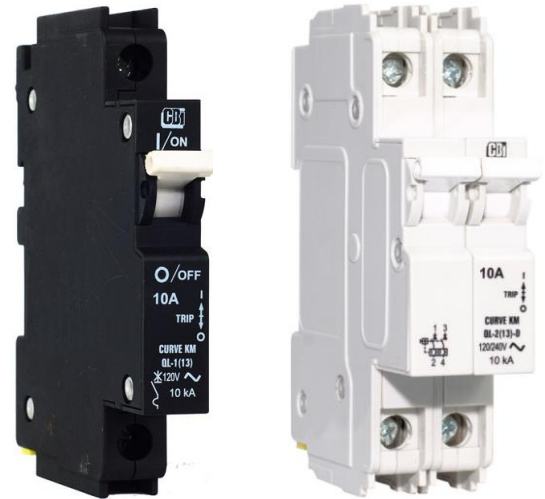

Features

- AC Circuit Breaker
- Hydraulic-Magnetic Technology
- 100% Rating Capability Independent of Ambient Temperature
- Up to Three Poles
- CSA, VDE, CE and CCC approved
- UL Listed (UL 489)
- Ratings up to 25A
- Optional Auxiliary / Trip Alarm Switch
- Wide Range of Time Delays and Operating Currents
- Precision tripping
- Current Limiting Capabilities
- Ultra Compact – 13mm width Module
- Trip Indication with Mid-Trip Handle
- Reset Immediately After Overload
- DIN and Dual Rail Mounting



Applications

- UPS Equipment
- Mobile Power-Generation Equipment
- Power Conditioning Equipment
- Alternative Energy Equipment
- Lighting Control
- AC Branch Circuit Installations



Technical Details

Approvals / Marks	UL 489 / CSA	IEC / EN 60947-2, VDE, CE, CCC ^(a)
Number of Poles	1, 2, 3	1, 2
Interrupting Capacity @ Operating Voltage	10kA @ 120VAC (1-pole) ⁽¹⁾ 5kA @ 240VAC (1-pole) ⁽²⁾ 10kA @ 120/240VAC (2-pole) ⁽³⁾ 5kA @ 240VAC (3-pole) ⁽⁴⁾	6kA @ 240VAC
Current Ratings	0.1 – 25A ^(1, 3 & 4) 0.1-20A ⁽²⁾	0.1 – 25A
Mounting Options	DIN Rail	
Tripping Curves	1, 9, KM	
Notes	^(a) GB 14048.2	

Circuit Breaker Industries Ltd.

Private Bag 2016, Isando 1600 • Tripswitch Drive, Elandsfontein, Gauteng, South Africa
Telephone: +27 928 2000 • Telefax: +27 11 392 2354 • e-mail: cbi@cbi.co.za • Reg. No. 05/15747/06

Established 1949

QL-Series Miniature Circuit Breakers

Optional Accessories

- Auxiliary Switch
- Auxiliary Switch + Trip Alarm
- Trip Alarm

Auxiliary Switch, Trip Alarm & Combo: Features

- AC and DC Voltages
- UL 489 Listed (Auxiliary switch: 6A 250V AC, 0.5A 80V DC; Trip alarm: 5A 250V AC, 0.5A 125V DC)
- IEC 60947-5-1 Approved (Auxiliary switch: 6A 250V AC, 0.5A 80V DC; Trip alarm: 5A 250V AC, 0.5A 125V DC)
- Factory Fitted
- Attached to Right Hand Side of Circuit Breaker
- Compact 6.5mm Width
- Available in Dual and DIN Rail Mounting

Standard Time Delay Curves

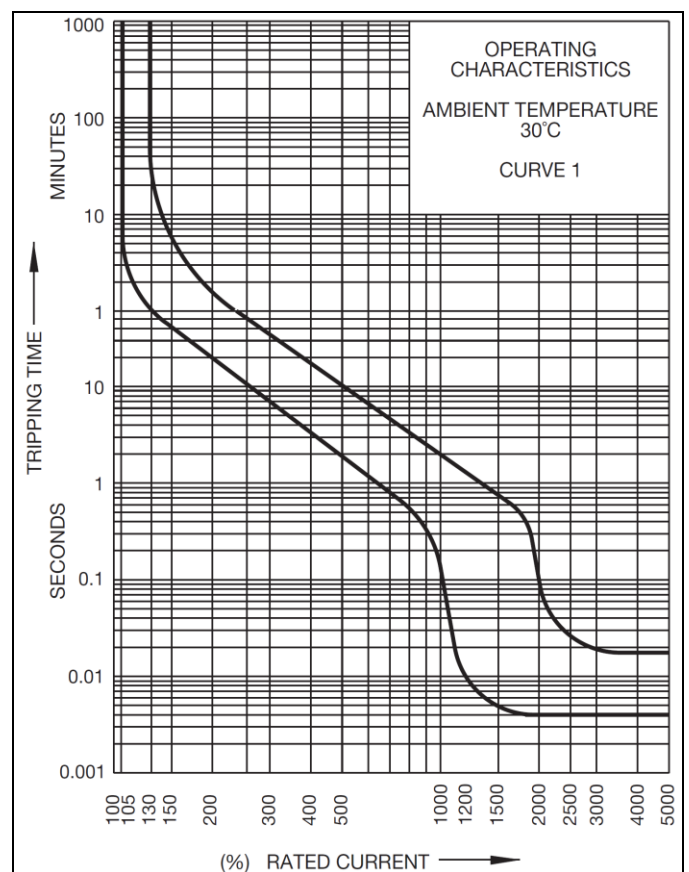
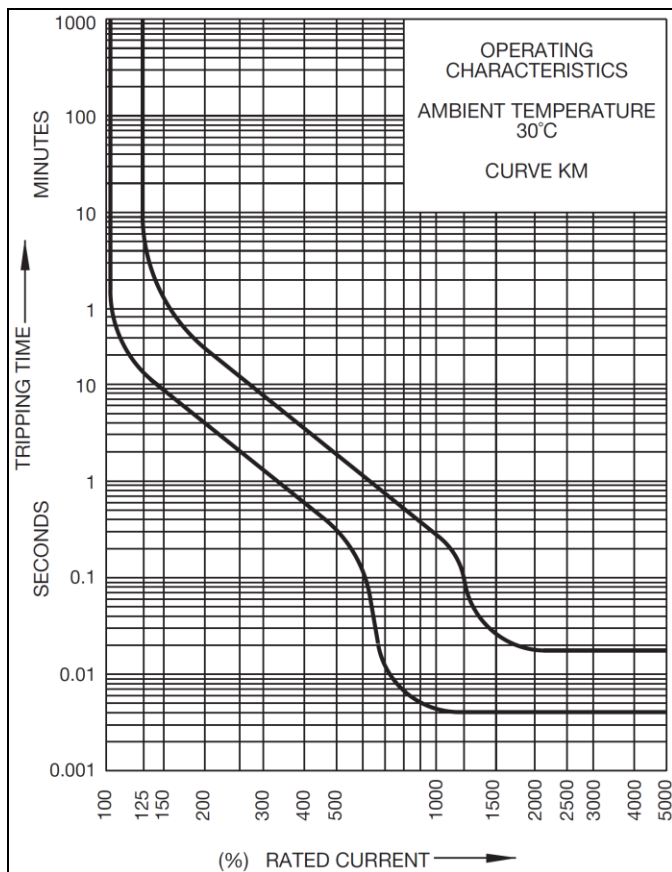

Circuit Breaker Industries Ltd.

Private Bag 2016, Isando 1600 • Tripswitch Drive, Elandsfontein, Gauteng, South Africa
Telephone: + 27 928 2000 • Telefax: + 27 11 392 2354 • e-mail: cbi@cbi.co.za • Reg. No. 05/15747/06

Established 1949

QL-Series Miniature Circuit Breakers

Internal Impedance vs Current Rating

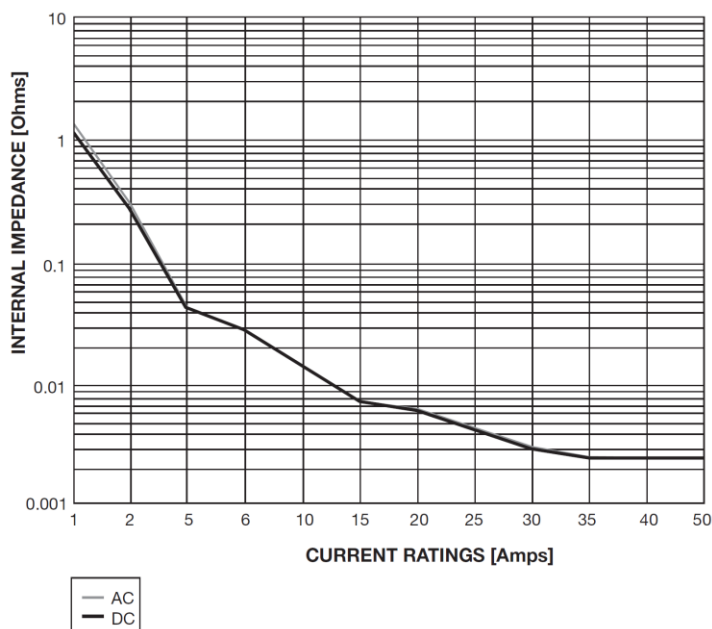

Ordering Code

Group 1: Frame Type	Code	Description	Comments	
	QL	13mm width miniature circuit breaker	UL 489, IEC / EN 60947-2, VDE, CE, CCC	
Group 2: Auxiliary Switch	Code	Description	Comments	
	A	Auxiliary switch	Leave blank if not applicable.	
	T	Trip alarm		
	AT	Auxiliary switch + trip alarm combo		
Group 3: Number of Poles	Code	Description	Comments	
	1	Single pole		
	2	Double pole		
Group 4: Module Width	Code	Description	Comments	
	(13)	13mm module width	13mm per pole	
Group 5: Mounting	Code	Description	Comments	
	D	DIN rail mount	45mm Escutcheon, Grey body	
	DM	Dual mount	57mm Escutcheon, Black body	
Group 6: Time Delay	Code	Description	Inst. Trip Point (x In)	Comments
	1	Long, high instantaneous trip	10 - 20	Orange handle
	9	Long	7 - 12	White handle
	KM	Medium	6 - 12	White handle
	OP	Instantaneous	None	White handle
Group 7: Current Ratings	Code	Description	Comments	
	0.1A	0.1A	Examples only. Any rating possible, from 0.1 - 25A.	
	01A	1A		
	1.5A	1.5A		
	05A	5A		
	10A	10A		
	25A	25A		

For options not listed, please contact CBI for assistance

Example code: QL - 1(13)-DM-KM-20A

Group	1	2	3	4	5	6	7
Requirement	QL Frame	No auxiliary	Single pole	13mm	Dual mount	Medium delay	20A
Long code	QL	-	- 1	- (13)	- DM	- KM	- 20A

Circuit Breaker Industries Ltd.

Private Bag 2016, Isando 1600 • Tripswitch Drive, Elandsfontein, Gauteng, South Africa
 Telephone: +27 928 2000 • Telefax: +27 11 392 2354 • e-mail: cbi@cbi.co.za • Reg. No. 05/15747/06

Established 1949

QL-Series Miniature Circuit Breakers

Auxiliary Outline Dimensions: DIN & Dual Mount

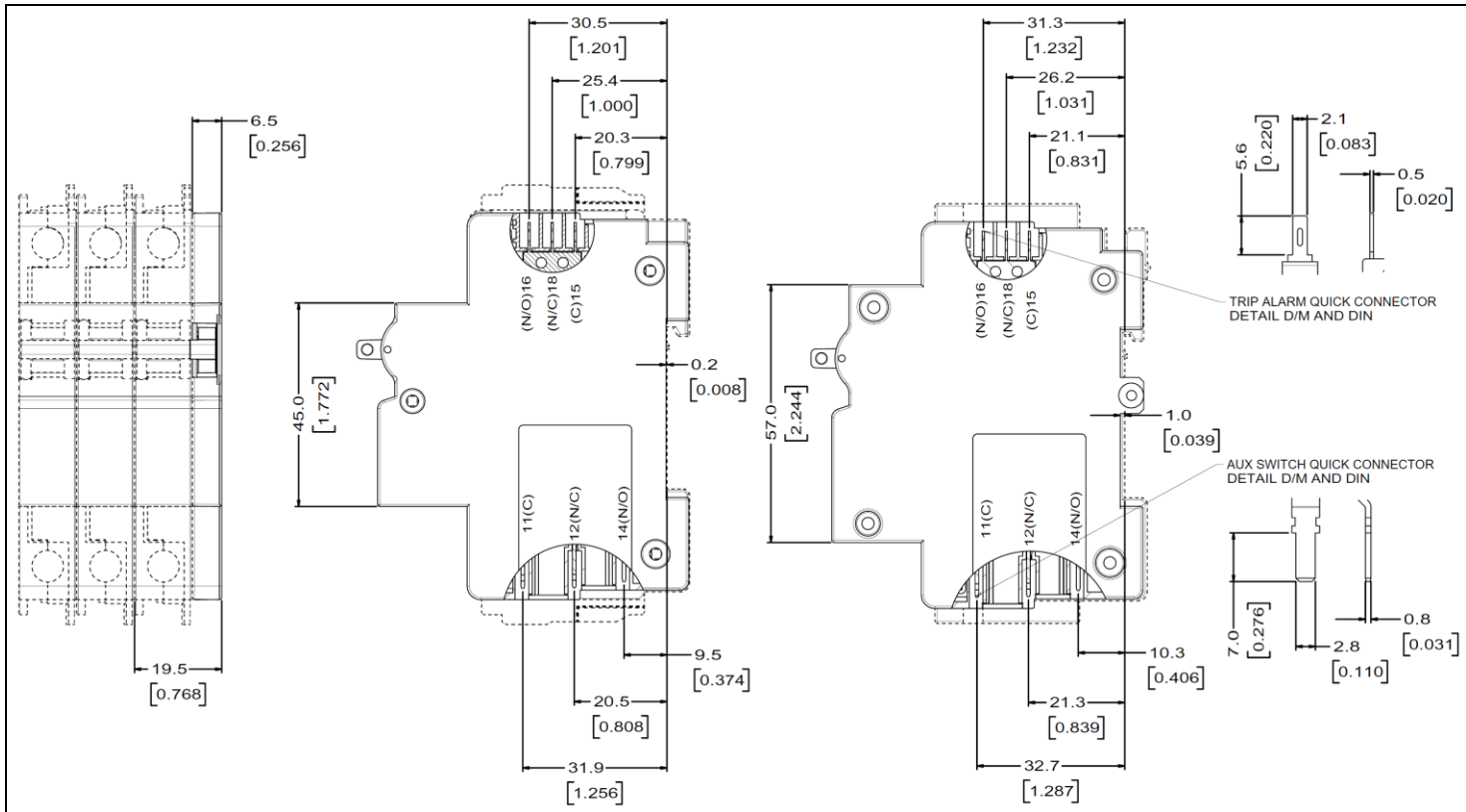

Circuit Breaker Industries Ltd.

Private Bag 2016, Isando 1600 • Tripswitch Drive, Elandsfontein, Gauteng, South Africa
 Telephone: + 27 928 2000 • Telefax: + 27 11 392 2354 • e-mail: cbi@cbi.co.za • Reg. No. 05/15747/06

Established 1949

QL-Series Miniature Circuit Breakers

Outline Dimensions: Dual Mount

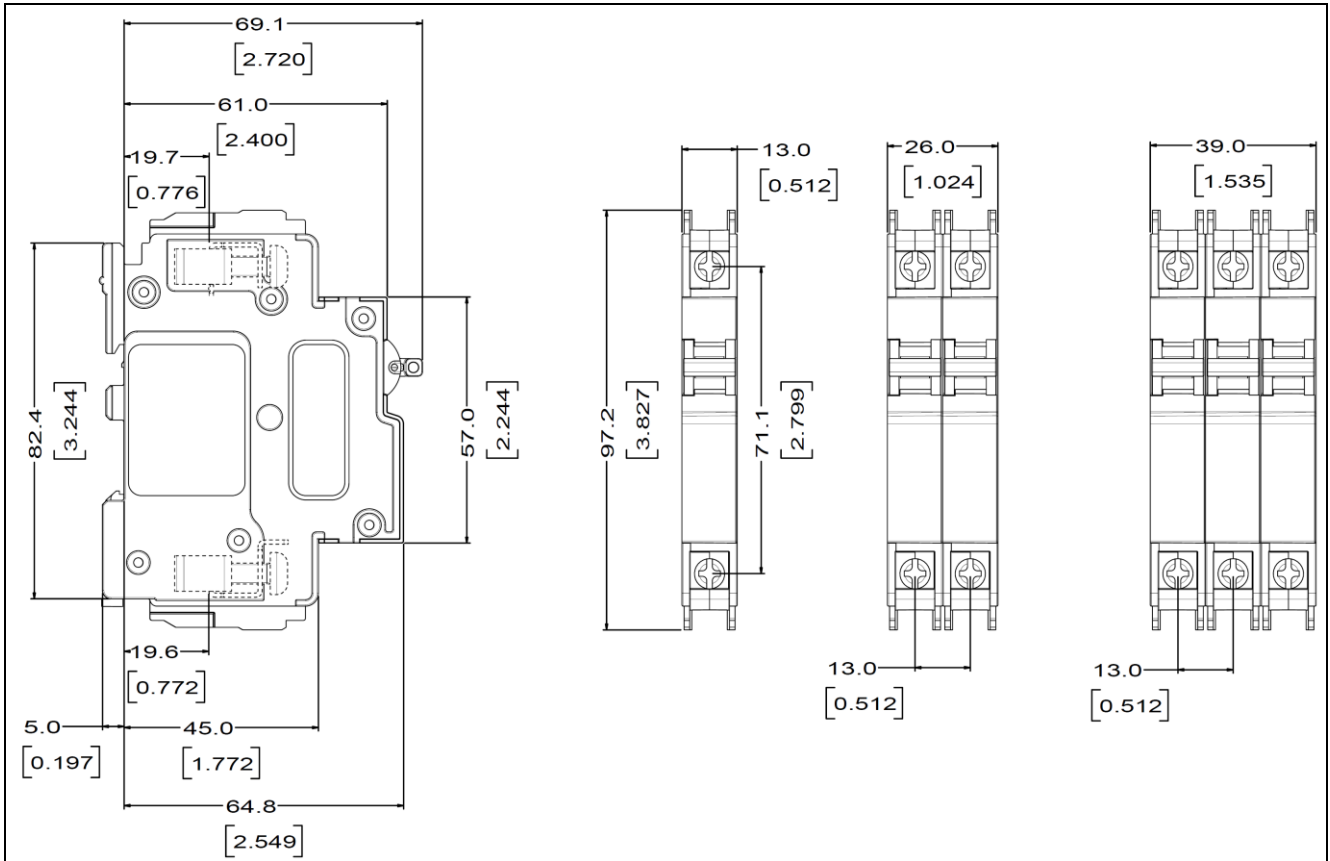

Outline Dimensions: DIN Mount

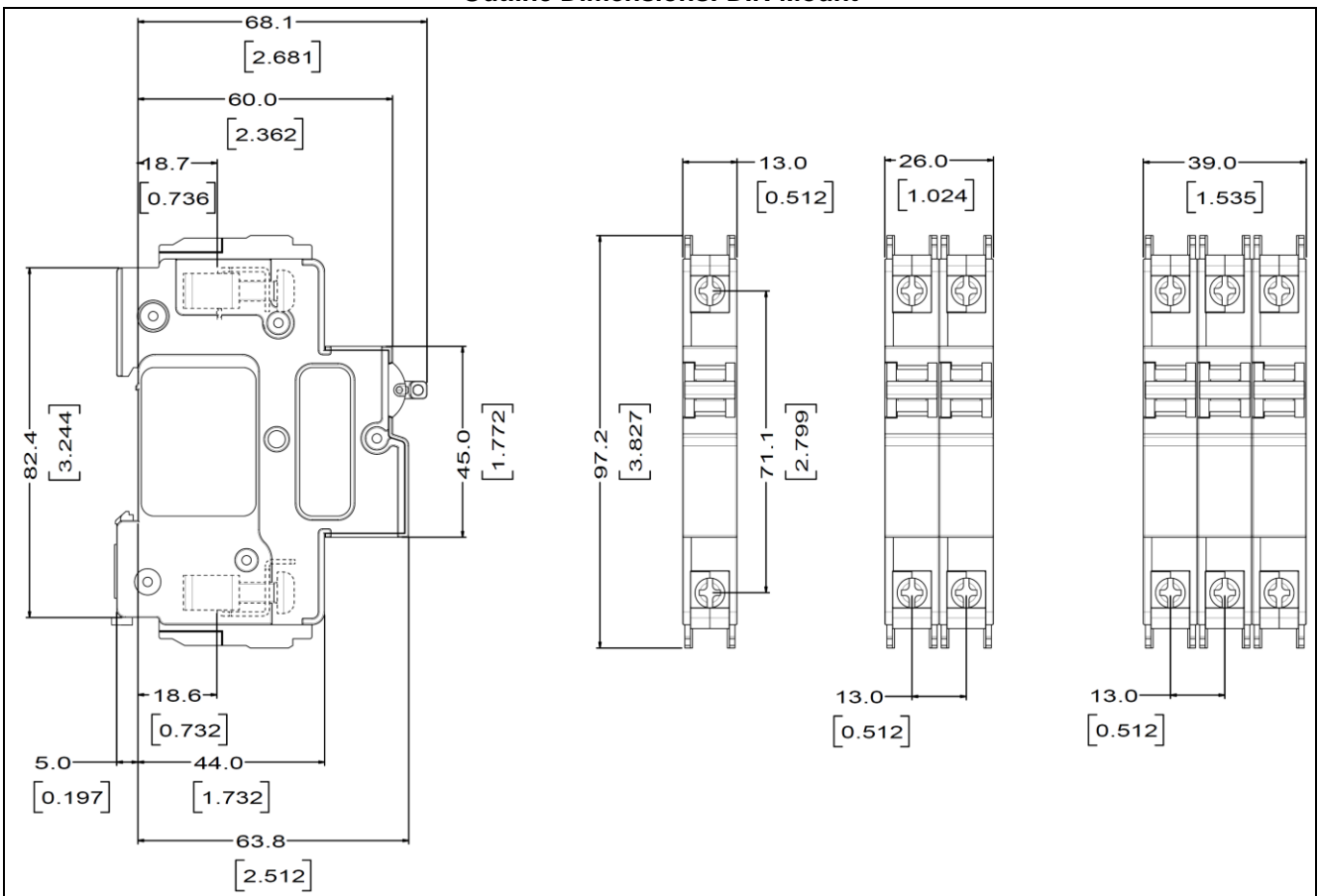

Circuit Breaker Industries Ltd.

Private Bag 2016, Isando 1600 • Tripswitch Drive, Elandsfontein, Gauteng, South Africa
 Telephone: +27 928 2000 • Telefax: +27 11 392 2354 • e-mail: cbi@cbi.co.za • Reg. No. 05/15747/06

Established 1949